

Fishfinder 250/250C

*high-resolution sonar
owner's manual*



(Fishfinder 250C shown)

© Copyright 2005 Garmin Ltd. or its subsidiaries

Garmin International, Inc.
1200 East 151st Street
Olathe, Kansas 66062, U.S.A.
Tel. 913/397.8200 or 800/800.1020
Fax 913/397.8282

Garmin (Europe) Ltd.
Unit 5, The Quadrangle
Abbey Park Industrial Estate
Romsey, SO51 9DL, U.K.
Tel. 44/0870.8501241
Fax 44/0870.8501251

Garmin Corporation
No. 68, Jangshu 2nd Road
Shijr, Taipei County, Taiwan
Tel. 886/2.2642.9199
Fax 886/2.2642.9099

All rights reserved. Except as expressly provided herein, no part of this manual may be reproduced, copied, transmitted, disseminated, downloaded or stored in any storage medium, for any purpose without the express prior written consent of Garmin. Garmin hereby grants permission to download a single copy of this manual onto a hard drive or other electronic storage medium to be viewed and to print one copy of this manual or of any revision hereto, provided that such electronic or printed copy of this manual must contain the complete text of this copyright notice and provided further that any unauthorized commercial distribution of this manual or any revision hereto is strictly prohibited.

Information in this document is subject to change without notice. Garmin reserves the right to change or improve its products and to make changes in the content without obligation to notify any person or organization of such changes or improvements. Visit the Garmin Web site (www.garmin.com) for current updates and supplemental information concerning the use and operation of this and other Garmin products.

Garmin[®], See-Thru[®], and DCG (Depth Control Gain)[®] are registered trademarks of Garmin Ltd. or its subsidiaries and may not be used without the express permission of Garmin.

INTRODUCTION

Thank you for choosing the Garmin® Fishfinder 250/250C. This product is designed for easy operation and to provide years of reliable service.

Operations for the Fishfinder 250 and Fishfinder 250C are the same unless otherwise noted. To ensure that you get the most from the Fishfinder 250/250C, take time to read this *Owner's Manual* and learn how to operate your new unit. This manual breaks down into three main sections. Getting Started covers the installation and testing for the Fishfinder 250/250C. Basic Operation provides detailed references to the features and operations of the Fishfinder 250/250C and a basic overview of how sonar works and provides information on interpreting sonar graphs. The Appendix contains unit specifications and warranty information.

Product Support

If you encounter a problem or just have a question, our Product Support Department can be reached Monday-Friday, 8 AM-5 PM Central Time.

Phone: 800/800.1020 or 913/397.8200

Online: <http://www.garmin.com/contactUs/techSupport.jsp>

Check the Garmin Web site (www.garmin.com) for links to Product Support and Product FAQs.

Fishfinder 250/250C Owner's Manual

Enjoy your new Fishfinder 250/250C, and once again thank you for choosing Garmin!

Product Registration

Help us to better support you by completing our online registration today! Connect to our Web site (www.garmin.com) and look for the Product Registration link on the Home page. Your unit's serial number is located on the back of the unit.

Use this area to record the serial number in case your Fishfinder 250/250C is lost, stolen, or in need of service. Be sure to keep your original sales receipt in a safe place or attach a photocopy to these instructions.

Serial Number: _____



NOTE: *If you have previously registered a Garmin product purchase, we invite you to re-register using our online system. Many services provided by our product registration system are now automated and re-registering your purchase ensures you the best possible support from Garmin.*

TABLE OF CONTENTS

Introduction	iii
Product Support	iii
Product Registration	iii
Getting Started	1
Packing List	1
Transducers	2
Optional Transducers	2
Installation	3
Selecting a Proper Location.....	3
Installing the Swivel Mount	3
Flush Mounting the Fishfinder 250/250C Unit.....	6
Connecting the Power/Data Cable.....	7
Interfacing.....	8
Installing the Transducer	10
Transom Mount Installation.....	10
Shoot-Thru-Hull Installation.....	11
Testing the Installation.....	12
Basic Operation	13
Using the Keypad	13
Using the Sonar Page	14
Using the Adjustment Menu	16
Adjustment Options.....	17
Pausing the Sonar Page.....	20

Using the Main Menu	21
Graph Tab	21
Tools Tab.....	23
Configuring Advanced Data Fields	23
Temp (Temperature) Tab	25
Alarms Tab.....	25
System Tab.....	27
Units Tab.....	28
Sonar Tab	28
Time Tab.....	30
Understanding Sonar	31
Transducer Coverage	32
Understanding the Graph.....	33
Whiteline	34
Thermoclines	35
Appendix	36
Physical Specifications	36
Power	36
Sonar	36
Cleaning and Storage	36
Messages and Alarms	37
Software License Agreement	38
Limited Warranty	38
Index	40

GETTING STARTED

Packing List

Before installing and using your Fishfinder 250/250C, check to see that your package includes the following items. The package part number can be found on the outside of the box. **If any parts are missing, contact your Garmin dealer immediately.**

Fishfinder 250 Standard Package (010-00343-00 w/o transducer):

- Fishfinder 250 Unit
- Swivel-Mount Bracket and Knobs
- Power/Data Cable
- *Owner's Manual*
- Self-Adhesive *Quick Reference Guide*
- Protective Cover
- Flush Mount Hardware Kit

Fishfinder 250 Optional Package (010-00343-01) includes Standard Package, plus:

- Dual Frequency (200/50kHz, 10/40°) Plastic Transom Mount Transducer with Depth and Temp

Fishfinder 250 Optional Package (010-00343-02) includes Standard Package, plus:

- Single Frequency (200kHz, 14°) Plastic Transom Mount Transducer with Depth and Temp

Fishfinder 250C Standard Package (010-00341-00 w/o transducer):

- Fishfinder 250C Unit
- Swivel-Mount Bracket and Knobs
- Power/Data Cable
- *Owner's Manual*
- Self-Adhesive *Quick Reference Guide*
- Protective Cover
- Flush Mount Hardware Kit

Fishfinder 250C Optional Package (010-00341-01) includes Standard Package, plus:

- Dual Frequency (200/50kHz, 10/40°) Plastic Transom Mount Transducer with Depth and Temp
- Separate Speed Sensor

Fishfinder 250C Optional Package (010-00341-02) includes Standard Package, plus:

- Single Frequency (200kHz, 14°) Plastic Transom Mount Transducer with Depth and Temp
- Separate Speed Sensor



NOTE: For the most recent list of available accessories for your unit, current user manuals, and software updates, visit our Web site at www.garmin.com.

Transducers

The transducer acts as the eyes and ears of your sonar, transmitting sound waves toward the bottom in a cone shape. Proper transducer selection and installation are important to the operation of your unit. Select a transducer that suits the depth of the water that you are on.

A wide cone angle transducer works best in shallower water, providing a large coverage or viewing area, but at a decreased bottom resolution. In deep water this can result in a large area where fish cannot be seen. A narrow cone angle transducer is better suited to deep water installations, providing a smaller coverage or viewing area than a wide cone transducer, but with improved bottom resolution and a smaller dead zone.

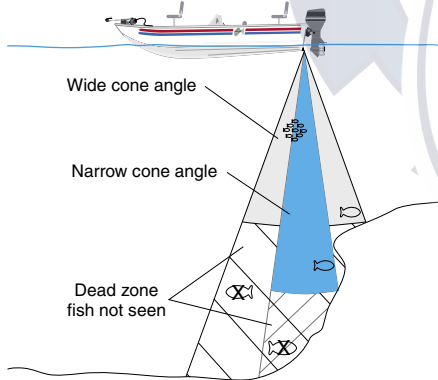

Optional Transducers

Included in the Optional Packages (page 1) are transom mount transducers and separate speed sensors. These transducers provide good all-around performance. In addition, a variety of optional transducers are available from your local dealer or direct from Garmin.

- 200/50kHz, 12/45°, plastic, transom mount, depth, temp
- 200/50kHz, 12/45°, plastic, transom mount, depth, temp, speed
- 200/50kHz, 12/45°, bronze, thru-hull mount, depth
- 200/50kHz, 12/45°, bronze, thru-hull mount, depth, temp, speed
- 200/50kHz, 12/45°, bronze, thru-hull mount/long stem, depth, temp, speed
- 200/50kHz, 12/45°, plastic, thru-hull mount, depth
- 200/50kHz, 12/45°, plastic, adjustable, in-hull mount
- 200kHz, 14°, plastic, transom mount, depth
- 200kHz, 14°, plastic, transom mount, depth, temp
- 200kHz, 14°, plastic, transom mount, depth, temp, speed
- 200kHz, 8°, plastic, transom mount, depth, temp
- 200kHz, 8°, plastic, transom mount, depth, temp, speed
- 200kHz, 12°, bronze, thru-hull mount, depth
- 200kHz, 12°, bronze, thru-hull mount, depth, temp
- 200kHz, 9°, bronze, thru-hull mount, depth, temp, speed
- 200kHz, 12°, plastic, thru-hull mount, depth
- 200kHz, 12°, plastic, thru-hull mount, depth, temp
- 200kHz, 14°, plastic, in-hull mount, depth
- 200kHz, 14°, plastic, trolling motor mount, depth, temp

Installation

The Fishfinder 250/250C must be properly installed according to the following instructions to get the best possible performance. To complete the installation, you need the appropriate fasteners and tools. Verify that all cables can reach the unit mounting location, and take time to read through these instructions prior to installation. Be sure to always wear safety goggles and a dust mask when drilling, cutting, or sanding. **If you experience difficulty installing the unit, contact Garmin Product Support or seek the assistance of a professional installer.**

Selecting a Proper Location

Choose a location that provides optimal viewing as you operate the vessel and allows easy access to the unit's keypad. Select a mounting surface capable of supporting the weight of the unit and protecting it from excessive vibration and shock. **DO NOT** mount the unit in an area exposed to extreme temperature conditions. When installing the mounting bracket, allow room for the routing and connection of the power and transducer cables.

Installing the Swivel Mount

The Fishfinder 250/250C's compact, waterproof case is suitable for mounting in exposed locations or at the nav station. The unit comes with a swivel-mount bracket that can be used for console or overhead mounting.

When choosing a location for the unit, consider the following conditions:

- There should be at least a 3" (8 cm) clearance behind the case to allow connection of the transducer and power/data cables.
- The mounting surface should be sturdy enough to support the unit and protect it from excessive vibration and shock.



***NOTE:** The temperature range for the Fishfinder 250/250C is 5°F to 130°F (-15°C to 55°C). Extended exposure to temperatures outside this range (in storage or operating conditions) may cause failure of the LCD screen. This type of failure and related consequences are NOT covered by the manufacturer's limited warranty.*

To install the swivel-mount bracket:

Tools (not included)—Drill, screwdriver (Phillips or standard), and either of the following:

- Three #8 (4mm) pan head machine bolts with matching nuts and washers and a 5/32" (5mm) drill bit.
 - Three #8 pan head self-tapping screws and an appropriately-sized drill bit for drilling starter holes.
1. Using the swivel base as a template, mark the location of the three holes that are used to secure the bracket to the mounting surface.
 2. Drill the mounting holes.
 - If securing the base with machine bolts, drill three 5/32" (5mm) holes at the locations you marked.
 - If securing the base with self-tapping screws, drill starter holes at the locations you marked. Starter holes should generally be no deeper than half the screw length.
 3. Secure the swivel base with three bolts or screws. **DO NOT OVERTIGHTEN.**
 4. Place the rest of the mount over the swivel base and secure with the short knob.



The swivel base is designed to be secured using a pan head screw or machine bolt. If you use a screw with a countersunk head, you risk damaging the mounting bracket.

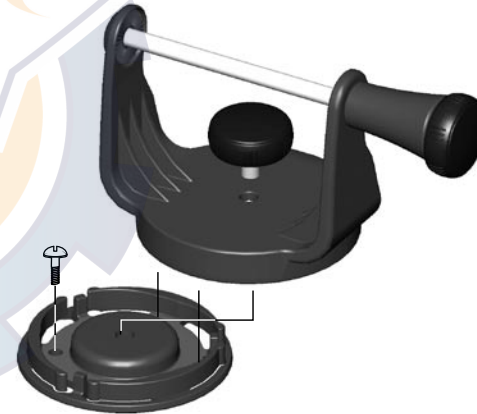

Secure the base and attach the mount.

To install the unit on the bracket

1. Align the slot on the back of the unit with the long mounting knob, and slide the unit into place. You may need to adjust the long mounting knob to spread the bracket arms apart. (Turn counter-clockwise to widen the bracket arms, clockwise to tighten.)
2. Adjust the unit angle and tighten the long mounting knob until snug.
3. To tilt the unit, loosen the long mounting knob on the right side of the bracket assembly.
4. To rotate the entire bracket, twist it left or right. The bracket clicks as you turn it.
5. Tighten all knobs once the desired viewing angle is obtained.



Slide the unit onto the bracket.



Adjust for optimal viewing.

Flush Mounting the Fishfinder 250/250C Unit

The Fishfinder 250/250C can be flush mounted on a flat panel. When flush mounting the Fishfinder 250/250C, choose an appropriately sized location for the unit. Use the Flush Mount Template provided in the box to determine a location. Check that all cables reach the unit mounting location before beginning installation. Always wear safety goggles and a dust mask when drilling, cutting, or sanding.

To flush mount the Fishfinder 250/250C:

Included mounting hardware—Four 3mm studs, four flat washers, and eight 3mm hex nuts.

Tools (not included)—Center punch, drill, 1/8" (3mm) drill bit, 3/8" (6mm) drill bit, jig saw, 1/16" (2mm) Allen wrench, and 9/32" (7mm) wrench.

1. Trim the Flush Mount Template and tape it in the appropriate location.
2. Using a center punch, indent the center of each mounting hole location.
3. Using a 1/8" (3mm) drill bit, drill the four mounting holes.
4. Using a 3/8" (6mm) drill bit, drill a hole for a location to begin cutting the mounting surface.
5. Using the jig saw, cut the mounting surface along the inside of the dashed line indicated on the template.



NOTE: *Be very careful when cutting this hole; there is only a small amount of clearance between the unit and the mounting holes. It may be prudent to cut slightly inside the indicated line and then sand or file the panel as needed to obtain the best fit.*

6. Install the four mounting studs into the unit by screwing the shorter section into the back of the unit. Use a 1/16" (2mm) Allen wrench to tighten the mounting studs until the stops contact the case. Be careful not to overtighten, as this may damage the mounting stud. The studs have a reusable thread-locking patch pre-applied from the factory.
7. Place the unit in position inside the cutout area of the mounting surface.
8. Place washers over the mounting studs, then thread on one hex nut per mounting stud. Tighten all four hex nuts until the unit is snug against the mounting surface. Install and tighten the second hex nut on all four mounting studs to lock the first hex nut in place.

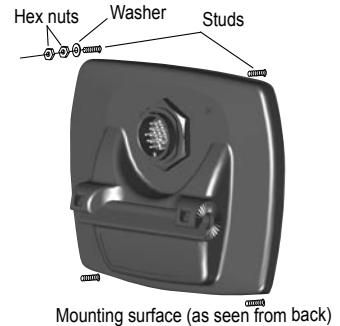

Connecting the Power/Data Cable

The power/data cable connects the Fishfinder 250/250C to a 10-35 Volt DC system and provides interface capabilities for connecting external devices. The color code in the diagram (page 9) indicates the appropriate harness connections. If it is necessary to extend the power/data wires, use a wire of comparable size and keep your extension as short as possible.

The unit can be wired directly to your boat's battery or to an unused holder on your boat's fuse block. When connecting the unit directly to the battery, make sure the 2-Amp in-line fuse supplied with the unit is installed. If needed, use a 2-Amp ACG/3AG replacement fuse. If you decide to route power through the boat's fuse block, remove the in-line fuse holder on the unit's power/data cable.

To connect the power/data cable to a voltage source:

1. Determine the polarity of the voltage source using a test light or voltmeter.
2. Connect the Red (+ or positive) wire to the positive voltage terminal. (If using the boat's fuse block, route the positive connection through the fuse, as shown on the diagram.)
3. Connect the Black (- or ground) wire to the negative voltage terminal.
4. Install or check the 2-Amp fuse (either on the boat's fuse block or in the in-line holder).

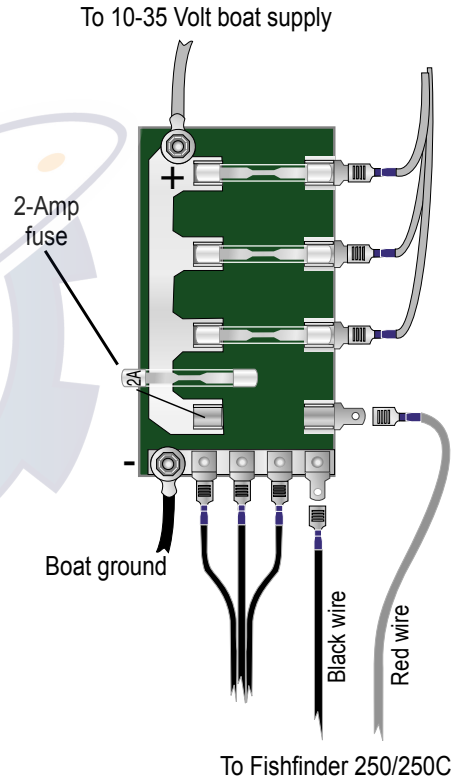

The Fishfinder 250/250C can be connected to another piece of NMEA compatible electronic equipment, such as a Garmin GPS (Global Positioning System). If equipped with a capable transducer, the Fishfinder 250/250C can send depth, temperature, and speed information to the NMEA device. It can also mark a location (page 20) that could be displayed on another device and can accept GPS navigational data (page 23), such as position, time, course, distance, etc. Refer to the wiring diagram on the following page for interfacing the Fishfinder 250/250C with other devices.

To connect the power/data cable to a GPS or other NMEA device:

1. Follow steps 1-4 of the voltage source installation (page 7). For Garmin units, the ground (Black) wires serve as data ground and must be attached together or on the same terminal. Refer to the wiring diagram of your GPS unit for wire identification.
2. Connect the Blue (Data OUT) wire from the Fishfinder to the Data IN wire on the GPS/NMEA harness.
3. Connect the Brown (Data IN) wire from the Fishfinder to the Data OUT wire on the GPS/NMEA harness.
4. Set the Fishfinder 250/250C **NMEA Input/Output** to **On** (page 27). For Garmin GPS units, set the communications interface to NMEA/NMEA, NMEA In/NMEA Out, or NMEA.

Interfacing

The Fishfinder 250/250C allows for NMEA 0183, Version 2.3 input/output with a compatible GPS or navigation device. **NMEA Input/Output** must be set to **On** to send/receive data (page 27). For additional information on using your Fishfinder 250/250C with NMEA devices, see pages 20 and 27.

The following sentences are for NMEA 0183, Version 2.3:

Input—GPBOD, GPBWC (only used if RMB not present), GPGGA, GPGLL (only used if GGA not present), GPRMB, GPRMC, GPXTE (only used if RMB not present)

Output—SDDBT, SDDPT, SDMTW, SDVHW, SDWPL* (only if a waypoint is “marked” in Pointer mode)

*Garmin GPS units will accept an SDWPL (WPL) NMEA sentence and create a waypoint (saved location) at that position (page 20). For compatibility with other brands of GPS or NMEA capable navigation devices, check with those manufacturers to see if their units accept/store NMEA 0183 SDWPL sentences/waypoints. The Fishfinder 250/250C does not store the actual waypoint. Only the receiving device, if capable, will store the waypoint.

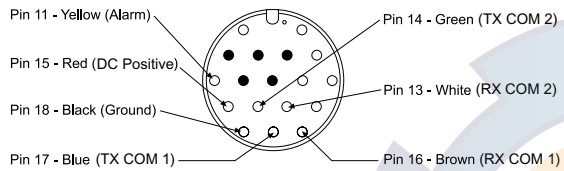

During a typical installation, only the Red and Black wires are used. The other wires do not have to be connected for normal operation of the unit.

Complete information concerning National Marine Electronics Association (NMEA) format and sentences is available for purchase from NMEA at:
 NMEA
 Seven Riggs Avenue
 Severna Park, MD 21146 U.S.A.
www.nmea.org

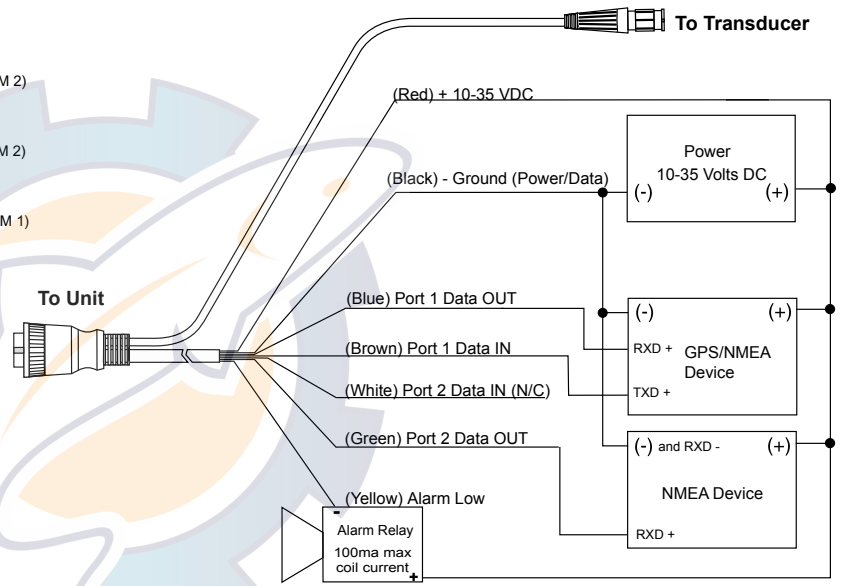

You can download a copy of Garmin's proprietary communication protocol document from the Support section of our Web site at www.garmin.com.

Installing the Transducer

Proper transducer installation is key to getting the best performance from your new unit. If the transducer lead is too short, extension cables are available from your Garmin dealer. Coil and secure any excess cable. **DO NOT** cut the transducer lead or any part of the transducer cable, as this will void your warranty. The cable cannot be spliced and connected to any existing (Garmin or non-Garmin) transducer cables.

Following are some tips and basic installation instructions for some popular transducers. **Detailed installation instructions are provided in the transducer kits.** Some transducers may need to be installed by a professional marine installer.

Transom Mount Installation

Transom Mount Transducer (depth/temp)



NOTE: *DO NOT* mount the transducer behind strakes, struts, fittings, water intake or discharge ports, or anything that creates air bubbles or causes the water to become turbulent. It is important that the transducer be in clean (non-turbulent) water for optimal performance.

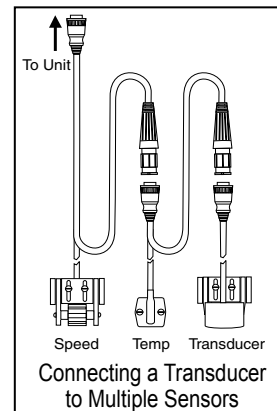
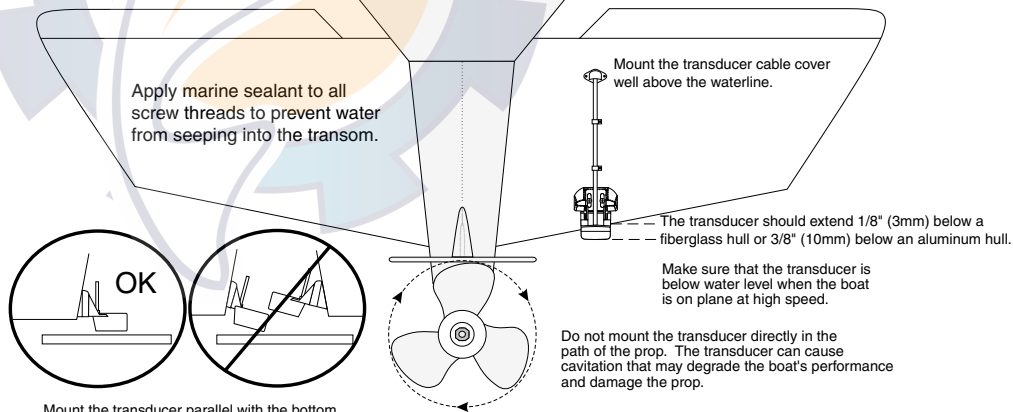

Shoot-Thru-Hull Installation

To avoid drilling a hole to mount a thru-hull transducer, a transducer may be secured with epoxy inside a boat (“shoot-thru-hull” installation). This type of installation can reduce noise and allow you to use a higher gain setting. For a transducer to be mounted inside the hull (shoot-thru, not thru-hull), the boat must be fiberglass, with no core. If you are unsure of your boat type, contact the manufacturer. Professional installation may be necessary. Always wear a dust mask and safety goggles when installing.

Some transducers are specifically designed to be mounted inside a fiberglass hull. The standard plastic transom mount transducer can also be mounted in this fashion using the following method. If using a temperature sensing transducer, the temperature displayed reflects the hull temperature.

When choosing a location for the transducer, consider the following conditions:

- The location has to be solid fiberglass, devoid of any air bubbles, laminates, fillers, or dead air space.
- The location needs to be in an area of clean water at all speeds.
- The location must not be over any strakes or behind any obstruction on the hull that would create turbulence at speed.



NOTE: Many modern hulls have a prelocated pocket for shoot-thru-hull transducer installation. If you are unsure if your hull is equipped with a pre-located pocket, contact your hull manufacturer.

To test the location:

1. Fabricate a test device from a section of PVC pipe or a can, as shown below.
2. Temporarily seal the test device to the hull with caulking or RTV sealer, and fill with water or light mineral oil.
3. Place the transducer in the liquid, pointed directly at the bottom. Weight it down. Set the unit for optimum performance. If the sonar performance is significantly degraded, find and test another location.

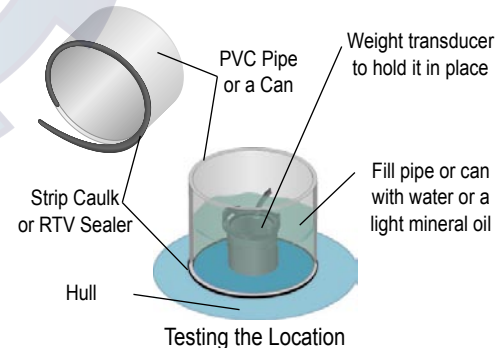

To permanently install the transducer:

1. Lightly sand the surface of the hull and face of the transducer with 400-grit wet or dry sandpaper.
2. Build a dam using strip caulk about 1/4" (6mm) tall. Pour about 1/8" (3mm) of two part, slow cure epoxy in the dam.
3. Place the transducer in the epoxy, turning the transducer to work out any air bubbles.
4. Weight the transducer in place and allow to cure for 24 hours.

Testing the Installation

Though it is possible to perform some checks with the boat trailered, the boat should be in the water to properly test the sonar installation.

Press the **POWER/BACKLIGHT** key (page 13) and the Fishfinder 250/250C should power on. If the unit fails to power on, verify that the power/data cable is seated properly in the back of the unit, the Red and Black wires are connected to the correct polarity, and the 2-Amp fuse is installed and not blown. If the unit is connected to a power supply that exceeds 35 Volts DC, a "Battery Voltage High" warning is displayed and the unit turns off. If the unit does not detect a transducer, it automatically enters Simulator mode.

When the unit detects a transducer on initial power up, a "Please set up transducer" message is displayed. Press the **ENTER** key (page 13) to select the transducer type. Highlight your transducer type with the **ARROW** keys and press **ENTER**. Press **ADJ/MENU** to return to the Sonar display.

Since water is necessary to carry the sounder's sonar signal, the transducer must be in the water to work properly. It is not possible to get a depth/distance reading when out of the water. As the unit powers on, it should immediately start showing the bottom. Verify that the unit is not in the Simulator mode. If the unit is in the Simulator mode, make sure that the transducer is connected properly to the unit. When you place your boat in the water, **CHECK FOR LEAKS** around any screw holes that have been added below the water line. **DO NOT** leave your boat in the water for an extended period of time without checking for leaks.

Begin testing the installation at a slow speed. If the sonar appears to be working properly, gradually increase the boat's speed while observing the sonar's operation. If the sonar signal suddenly is lost or the bottom return is severely degraded, note the speed at which this occurs. Return the boat to the speed the signal was lost. Make moderate turns in both directions and see if the signal improves. If the signal strength improves while turning, adjust the transducer so that it extends another 1/8" (3mm) below the transom of the boat. It may take several adjustments to eliminate the degradation. If the signal does not improve, it may be necessary to move the transducer to a different location.



NOTE: When adjusting the depth of the transducer, make the adjustments in small increments. Placing the transducer too deep can adversely affect the boat's performance and put the transducer at greater risk of striking underwater objects.

BASIC OPERATION

Using the Keypad



NOTE: Press and release a key to activate its primary function. Pressing and holding a key activates its secondary function (if available).

The keypad contains the following keys:

ARROW Keys—press to select (highlight) menu options and enter data. Press to control movement of the cursor when paused in Pointer mode. Allows direct control of Sonar page adjustments.

ENTER Key—press to select a highlighted menu option. When entering data, allows you to initiate entry and then accept the selected value(s). When paused in Pointer mode, press to create a waypoint at the Pointer position (if interfaced with compatible NMEA GPS).

ADJ/MENU Key—from the Sonar screen, press and release to display the Adjustment Menu. Press and hold to access the Main Menu for unit configuration. From either menu, press and release to return to the Sonar page.

POWER/BACKLIGHT Key—press and hold to turn the unit on and off. While the unit is on, press and release to display the light/contrast adjustment window. See page 14 for more information.



Using the Sonar Page

The Sonar page is where your Fishfinder 250/250C becomes a powerful fishfinder/flasher. If the unit does not detect a transducer, a “Sonar Turned Off” message is displayed on the Sonar page. If in Simulator mode, a “Running Simulator” message appears.

You can adjust the unit’s backlight and contrast settings to improve screen readability.

To change the backlight/contrast settings:

1. Press and release **POWER/BACKLIGHT** to display the light/contrast adjustment window. The adjustment window automatically disappears when idle for 20 seconds.
2. Press the Up or Down **ARROW** keys to change the backlight setting. Press and release **POWER/BACKLIGHT** to toggle the backlight setting between maximum, user-set, and minimum brightness levels.
3. Press the Left or Right **ARROW** keys to change the contrast setting.
4. Press **ENTER** to return to the Sonar page.

The currently selected adjustment option (page 17) is displayed in the top left of the screen. Directly below the adjustment option, the screen displays numeric data such as **Depth**, **Water Temperature** and **Water Speed** (pages 23-24). The middle of the page contains a right-to-left moving sonar image of the water beneath your boat. Items appear as they pass under your transducer. Items on the right side of the screen are closer to you than those on the left. Along the right side of the screen is a scale that reflects the depth of the area being displayed.

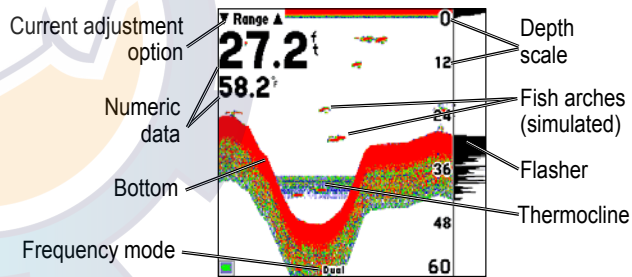

The display may also be set to show a split screen view of a zoomed portion of the sonar, bottom lock (display scaled from the bottom up), or a combination of these options (pages 17-18). For example, you may choose to show dual frequency at a 2x zoom (Dual 2x) on one half of the screen, with normal range dual frequency (Dual) on the other half. The current display mode is shown at the bottom of each sonar display.

The Fishfinder 250 displays sonar returns as shades of gray; stronger returns are darker, and weaker returns are lighter. On the Fishfinder 250C, sonar returns are displayed as red (strongest), orange (strong), yellow (medium), green (weaker), and blue (weakest).

The **Fish Symbols** option (page 22) allows you to find fish by viewing the actual sonar data, a fish symbol or a combination of both. Fish symbols appear as black on the Fishfinder 250 and green on the Fishfinder 250C. When **Frequency** is set to **Dual** (page 14), the appearance of the fish symbols (and simulated fish returns) will change. Fish symbols from the narrower beam (200kHz) will be solid (narrow returns), but the returns from the wider beam (50kHz) will be hollow (wide returns). Simulated fish icons are displayed in three different sizes based on the size of the return. Actual fish returns may not always appear as perfect arches, due to the speed, fish orientation, and/or other conditions.

For more information on understanding the sonar, see pages 31-33.

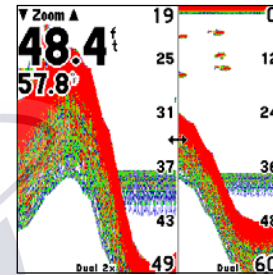

Split screen view

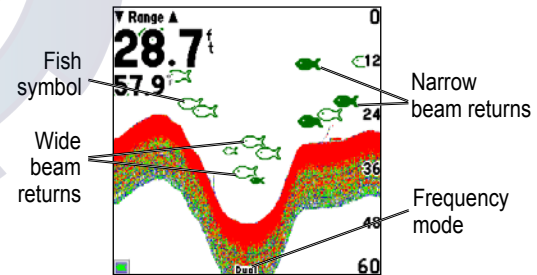

Fish symbols

Using the Adjustment Menu

The Adjustment Menu allows direct access to the settings and features most commonly used on the Sonar page. There are 10 main adjustment options available: **Range**, **Zoom**, **View**, **Gain**, **Target Level**, **Whiteline**, **Frequency**, **Depth Line**, **Noise Reject**, and **Scroll**. All adjustments may be made by using the **ARROW** keys and **ENTER** key. The currently selected option will appear in the upper left of the display with up and down arrows on either side of the name.

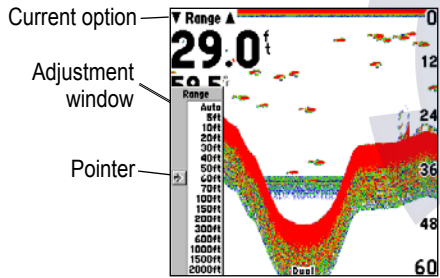

To change an Adjustment Menu setting:

1. Press **ADJ/MENU** to display a list of all options and their current settings. The adjustment window automatically disappears when idle for 20 seconds, or you may press **ADJ/MENU** to exit.

2. Press the Up or Down **ARROW** keys to highlight the desired option and press **ENTER** to display the adjustment window.
3. Press the Up or Down **ARROW** keys to move the setting bar (or pointer) to the desired percentage (**Off**, **1-100%**), setting, or range. When changing most adjustment settings, an open space is displayed on the scale to indicate the **Normal** or default setting. Once set to **Normal**, the setting bar is replaced by the word **Normal**.
4. Press **ENTER** to accept the new setting and return to the Sonar page.

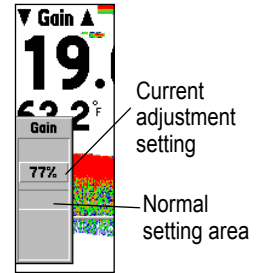

The current adjustment option is displayed in the upper left corner of the screen. For fast adjustment from the Sonar page, press the Left or Right **ARROW** keys to scroll through the options. Press the Up or Down **ARROW** keys to change the current setting or press the **ENTER** key to review the setting before making changes.

Adjustment Options

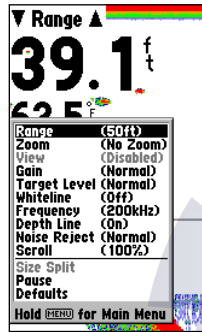

Adjustment Menu

The following adjustments can be made from the Adjustment Menu:

- **Range**—sets the display depth range used for viewing. The unit can be set to automatically track the bottom or set to a user-specified depth range (see “Custom Range” on page 22).
- **Zoom**—quickly selects a display zoom scale or to split the display. When a scale other than **No Zoom** is selected, the **View** or **Span** options are activated in the Adjustment Menu.

The Zoom function includes the following seven settings:

No Zoom—displays the sonar picture with no zoom.

2x Split—shows two reduced-size sonar pictures at the same time. The right half of the display screen shows the complete sonar picture at its original scale. The left half shows a portion of the original picture at 1/2 depth scale.

2x Zoom—displays the 2x zoomed picture on the full screen and does not show the original scale picture.

4x Split—shows two reduced pictures, the right at the original depth scale and the left at 1/4 the original depth scale.

4x Zoom—displays only the 4x zoomed picture on the full screen.

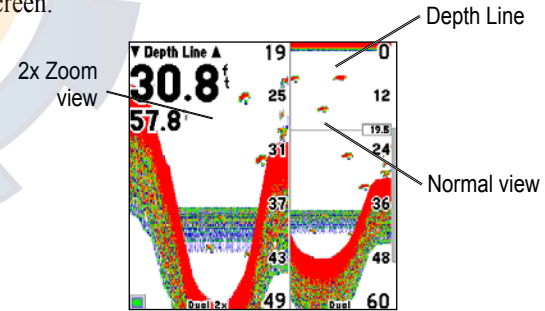

Sonar 2x split screen (shown with Depth Line)

Btm (Bottom) Split—shows two reduced pictures, the right at the original depth scale and the left showing only sonar returns close to the bottom. The bottom is displayed as a flat line across the bottom of the screen, and returns are shown at their distance from the bottom. You can adjust the scale of the **Bottom Split** display by changing the **Span** setting (see below).

Btm (Bottom) Lock—displays the **Bottom Lock** (returns close to the bottom, shown at their distance from the bottom) picture on the full screen. You can adjust the scale of the **Bottom Lock** display by changing the **Span** setting (see below).

- **View/Span**—available when a **Zoom** scale other than **No Zoom** is selected. The **View** or **Span** settings are used to change the viewing range of a zoomed display. The **View** option is enabled when the display is set to **2x Split**, **2x Zoom**, **4x Split**, or **4x Zoom**. If the display is 2x or 4x split, only the zoomed portion on the left side of the display is affected by the change. If the display is **Bottom Split** or **Bottom Lock**, the **Span** option adjusts the area from the bottom for which the unit displays data.
- **Gain**—controls the sensitivity of the unit’s receiver. This provides some flexibility in what is seen on the display. To see more detail, increase the receiver sensitivity by selecting

a higher gain percentage. If there is too much detail or if the screen is cluttered, lowering the sensitivity may increase the clarity of the display.

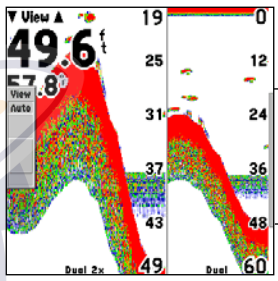

Sonar view adjustment

- **Target Level**—adjusts which colors (Fishfinder 250C) or shades of gray (Fishfinder 250) are used to display sonar information. A **Color Bar** (page 23) is displayed on the right side of the screen as you adjust this setting. A higher percentage results in more strong-signaled colors or shades (page 15) displayed on the Sonar page. A lower percentage results in more weaker-signaled colors or shades (page 15) displayed on the Sonar page. This setting does not increase/decrease the unit **Gain**.
- **Whiteline**—controls how the unit displays information about the bottom type (hard or soft). When turned **Off**, all high-intensity bottom returns are displayed as red on the Fishfinder

250C and black on the Fishfinder 250. When set at **Normal** or **1-100%**, this option can be used to better determine bottom hardness. See page 34 for more information on this feature.

- **Frequency**—allows you to choose a sonar operation frequency. The frequency is the “pitch” of the sound that the transducer sends and receives. You may choose **200kHz**, **50kHz**, or **Dual** frequency (when using a dual frequency transducer).
- **Depth Line**—adds a horizontal depth line across the display to measure the depth of underwater objects. The depth of the line is displayed in a box on the right side of the line. When the **Depth Line** adjustment window is visible, press the Up or Down **ARROW** keys to control the position of the line on the graph.
- **Noise Reject**—helps filter unwanted noise from the graph. This option can be turned **Off**, set to **Normal** (automatically adjusts for optimum viewing), or set to a fixed **1-100%** setting. Higher noise rejection settings make the unit less likely to show fish or structures.
- **Scroll**—adjusts the rate that the graph scrolls from right to left. If you are sitting still or the graph is moving too fast, slowing the scroll rate or pausing it can be beneficial. **Auto** automatically adjusts the scroll rate according to the boat’s speed. (See also “Automatic Scroll Speed Limit” on page 29.)

- **Size Split**—enables width adjustment of the Sonar page split screen. This option is only available when a split zoom is selected. You may adjust the size of the split window anywhere from 1/4 to 3/4 width from the right half of the Sonar page.
- **Defaults**—restores adjustment options back to original factory settings.

To resize the Sonar page split screen:

1. From the Sonar page split screen, press **ADJ/MENU**.
2. Using the **ARROW** keys, highlight the **Size Split** option and press **ENTER**. A small double-arrow is displayed in the middle of the split line on the screen.
3. Press the Left or Right **ARROW** keys to move the split line. Press **ENTER** when the line reaches a suitable location.

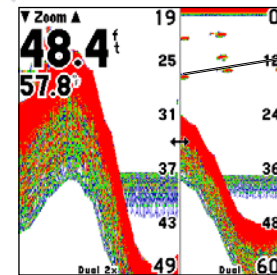

You may resize the split line to the left or the right.

Resizing the Sonar page split screen

Pausing the Sonar Page

You may pause the Sonar page to stop it from scrolling. The paused screen allows you to take a better look at sonar returns. When in this mode, the word “Paused” is displayed at the bottom of the screen and a Pointer cursor appears. You may move the Pointer around on the paused sonar graph in order to reference sonar items and mark waypoints for that location (if attached to a Garmin GPS or compatible NMEA navigation device; see page 8). A data field is displayed at the top of the graph with the Pointer’s depth, surface temperature for that position, and GPS coordinates (if available). This makes it easier to find and use objects such as stumps, rocks, or brush piles for future fishing locations. The depth continues to update while the display is paused, but the unit does not show any new sonar data until the Sonar display is unpaused (resumed). You may see a discontinuity from where the sonar information stops to where it starts again.

To pause and unpaue the Sonar display:

1. From the Sonar page, press **ADJ/MENU**.
2. Using the **ARROW** keys, highlight the **Pause** option and press **ENTER**. The Sonar display is paused. The Pointer cursor appears and data fields for the Pointer appear at the top of the screen.
3. To unpaue the Sonar display, press **ADJ/MENU**, highlight the **Resume** option and press **ENTER**.

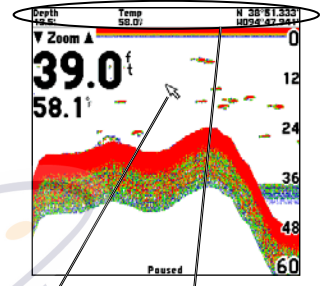

As you move the Pointer, the depth, temp, and position (if available) are displayed at the top of the screen.

To mark a remote waypoint:

1. With the Sonar display paused, use the **ARROW** keys to move the cursor onto the target you want to mark. A data field appears with the cursor’s depth, surface temperature for that position and GPS coordinates.
2. Press **ENTER**. The New Waypoint window appears with a default four-character name (a three-digit number preceded by “S” to designate a waypoint marked with sonar) and the pointer’s coordinates automatically filled in.
3. To change the name, highlight the name field and press **ENTER**. Make your changes using the **ARROW** keys and press **ENTER** when done.
4. When finished, move the field highlight back to **OK** and press **ENTER**. The unit sends a NMEA WPL sentence to the attached GPS unit or NMEA navigational device (pages 8-9).

Using the Main Menu

The Main Menu contains the unit settings that usually do not require frequent change. The Main Menu is divided into eight tabs: Graph, Tools, Temp, Alarms, System, Units, Sonar, and Time. Each tab is described in more detail in this section.

To enter the Main Menu, press and hold the **ADJ/MENU** key. The first time you enter the Main Menu, the Graph tab is highlighted in black. Press the Up or Down **ARROW** keys to highlight different tab selections. Press the Right **ARROW** key to access the selection fields. Each time the Main Menu is accessed, the unit returns to the last edited selection field. Press the Left **ARROW** key to return to the tabs.

To change a setting on a Main Menu tab:

1. Using the **ARROW** keys, highlight the desired field and press **ENTER**.
2. Highlight the desired setting and press **ENTER**.
3. Press **ADJ/MENU** to return to the Sonar display or to cancel data entry.

Graph Tab

The Graph tab allows you to determine the appearance of the scrolling graph display and contains unit settings that usually do not require frequent change.

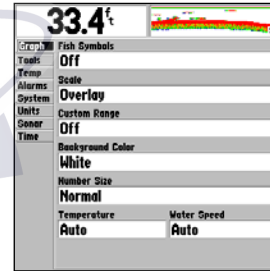

Main Menu—Graph tab

The following settings are available:

- **Fish Symbols**—controls how the graph shows underwater targets and background information. If the symbols are **Off**, the unit displays all of the available information about the underwater environment. If the symbols are **On**, the graph displays only the information related to those symbols.

Off Fish Symbols Off—All available information is displayed.



Suspended targets are displayed as fish symbols. Background information is displayed.



Same as above with the target depth attached.



Suspended targets are displayed as fish symbols. No background information is displayed.



Same as above with the target depth attached.

- **Scale**—controls the presentation of the depth scale displayed vertically along the right side of the graph. The depth scale display can be configured four different ways: **Overlay**, **Corners**, **Basic**, or **No Scale**.
- **Custom Range**—allows you to specify a custom viewing range/scale. Once enabled, this range is displayed as **Custom** in the **Range** adjustment control. The left value is the top of the scale and the right value is the bottom of the scale.
- **Background Color (Fishfinder 250C only)**—allows you to change the background color of the Sonar display. Choices are **Black**, **Blue**, and **White**.
- **Number Size**—allows you to choose between a **Normal** or **Large** sized **Basic** depth/temp/speed display. This does not change the advanced data field number sizes.
- **Temperature and Water Speed**—hides or displays temperature and water speed on the Sonar page. When set to **Auto**, the unit automatically displays this information only if it is received from the transducer.

Tools Tab

The Tools tab controls the display of useful sonar tools.

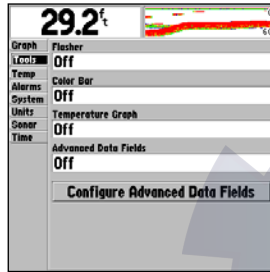

Main Menu—Tools tab

The following settings are available:

- **Flasher**—this option activates a graphic flasher representation, displayed on the right side of the graph. The graphic flasher displays structure and bottom returns much the same as a true flasher. You may find this feature particularly useful when using fish symbols (pages 15, 22).
- **Color Bar**—shows a gradient scale of the current **Target Level** setting (page 18).
- **Temperature Graph**—toggles **On** or **Off** the display of a temperature graph on the Sonar page.

- **Advanced Data Fields**—toggles **On** or **Off** the advanced data fields on the Sonar page.
- **Configure Advanced Data Fields**—activates the advanced data field setup screen.

Configuring Advanced Data Fields

The top left of the screen contains configurable data fields for the Sonar display. By default, the **Basic** display shows **Depth**, **Water Temperature**, and **Speed** (depending on the Graph tab settings and type of transducer/sensors attached). The **Configure Advanced Data Fields** option in the Tools tab allows you to customize the data fields that appear. The data field setup screen shows a larger, configurable data field with a white background. The setup screen allows you to select the type of data displayed and either a **Narrow** (small) or **Wide** (large) size format for each data field.

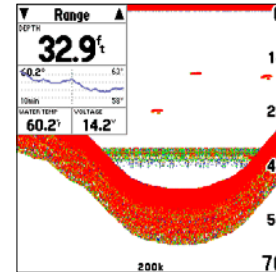

Sonar page with advanced data fields

The following selections require the proper NMEA data (pages 8-9) in order to display information in a data field: **Bearing, Compass, Course, Distance to Next, Off Course, Pointer, Position, Speed, Time of Day, Track, Turn, and VMG.** NMEA Input/Output must also be enabled to receive this data (page 27).

To toggle the data field display:

1. Use the **ARROW** keys to highlight **Advanced Data Fields** and press **ENTER**.
2. Select **On** or **Off** and press **ENTER**.

To open the advanced data field setup screen, use the **ARROW** keys to highlight **Configure Advanced Data Fields** and press **ENTER**.

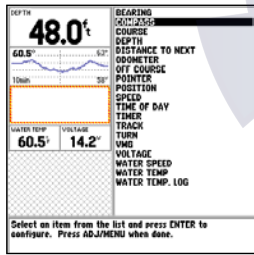

Advanced data field setup screen

You may either directly edit an existing field on the left or add a new data field from the list on the right. Highlighted items on the right

appear with a black background and the associated field on the left is outlined with a moving dotted line.

To modify or add a data field:

1. Using the **ARROW** keys, press Left to modify an existing field or Right to add a new one, then press Up or Down to highlight the desired item. Press **ENTER**. The available options appear on the right.
2. Select an option from the list on the right and press **ENTER**. You may choose to display a **Wide** or **Narrow** sized format (some data fields are only available in **Wide** format), arrange the display order with **Move Up** or **Move Down** (**Narrow** data fields always arrange below **Wide** data fields), **Remove** a data field, or **Replace** a data field. For **Replace**, choose a replacement item from the list and press **ENTER**.
3. Highlight **OK** and press **ENTER** to save changes.



Modifying a data field

Temp (Temperature) Tab

The Temp tab displays the water temperature log (if equipped with a temperature transducer/sensor). The graph reads from right to left, so the most recent temperature measured is displayed on the far right side of the graph. The dotted lines within the graph indicate intervals in the temperature scale and the duration of time.

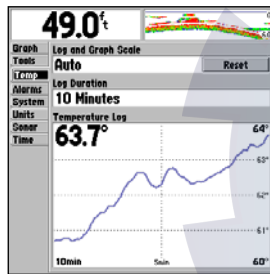

Main Menu—Temp tab

The following settings are available:

- **Log and Graph Scale**—sets the temperature range (in degrees) for displaying the log. Select **Auto** to have the unit determine the best range, or select a span of 2, 4, 6, 8, or 10 degrees.

- **Reset (Scale)**—resets the scale range for the temperature graph (and displays if **Log and Graph Scale** is set to **Auto**). This is useful when the scale spans a large range due to extreme temperature changes.
- **Log Duration**—sets how fast or slow the temperature log scrolls; the shorter the time duration, the faster the temperature log scroll. Select a duration from 1 minute to 2.5 hours.

Alarms Tab

The Alarms tab contains settings for the unit's alarms. (For a list of alarms and unit messages, see page 37.) This tab is divided into two subtabs—Sonar and System.

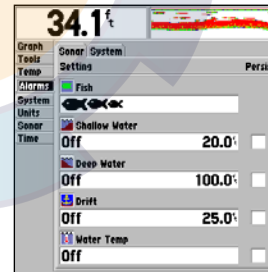

Main Menu—Alarms tab
Sonar subtab

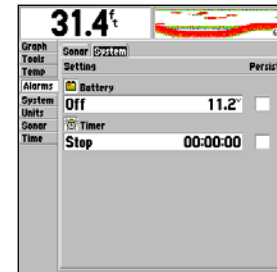

Main Menu—Alarms tab
System subtab

Sonar alarms:

- **Fish**—sets an alarm/icon to sound/display when the unit detects a fish of the specified symbol size.
- **Shallow Water/Deep Water**—sets alarms to sound for when you enter areas of specified depth that are too shallow or too deep.
- **Drift**—sets an alarm to sound when you've exceeded a specified drift depth range. For example, if the value is set to 5 ft. and the current depth is 20 ft., the alarm will sound if the unit detects a depth greater than 25 ft. or shallower than 15 ft.
- **Water Temperature**—sets an alarm to sound when the transducer reports a temperature above, below, inside, or outside the specified values.

System alarms:

- **Battery**—sets an alarm to sound when the battery nears a critical state of discharge.
- **Timer**—allows you to set, stop, or reset a timer. With the **Count Dn** (Down) and **Count Up** settings you may specify the duration of the timer count.

To set an alarm:

1. Use the **ARROW** keys to highlight the desired subtab of the Alarms tab.
2. Highlight the field below the alarm name you wish to activate and press **ENTER**.
3. Change the mode to the desired setting and press **ENTER**.
4. Highlight the next field to the right and press **ENTER**, then enter the desired settings and press **ENTER** to finish.
5. If you want the alarm to display and beep until acknowledged, highlight the **Persist** box and press **ENTER** to place a check mark in the box.

System Tab

The System tab controls various system and interface settings.



Main Menu—System tab

The following settings are available:

- **Beeper**—controls audible beep. Select from **Off**, **Alarms Only** (sounds for alarms/messages), or **Key and Alarm** (sounds for key presses and alarms/messages).
- **Display Mode**—select **Fishfinder** to display the scrolling sonar image on the Sonar page, or select **Depth Sounder** to show only numeric data for **Depth**, **Water Temp**, and **Water Speed**.
- **Language**—select from various languages for the unit's on-screen display.

- **Simulator**—lets you simulate unit operation using a Depth Only, Depth/Temp, Depth/Speed, or Depth/Temp/Speed transducer. If prompted, choose **No** to the retail demonstration mode for normal consumer simulator use. If the unit does not detect a transducer, it will automatically enter Simulator mode. While in Simulator mode, a “Running Simulator” message appears after 2 minutes of inactivity.
- **NMEA Input/Output**—controls the input/output of NMEA 0183 Version 2.3 data to/from the unit. This setting must be **On** in order to receive GPS navigational data and send Sonar NMEA data. See pages 8-9 for details on available NMEA sentences.
- **Factory Settings**—restores all settings to the original factory default values for the entire unit.
- **Software Version**—displays the unit's software version and electronic serial number.
- **Reset Odometer**—this will only appear if you are using a speed-capable transducer/sensor. Resets the odometer field back to zero. See “Configuring Advanced Data Fields” on page 23 for more information.

Units Tab

The Units tab defines units of measure.

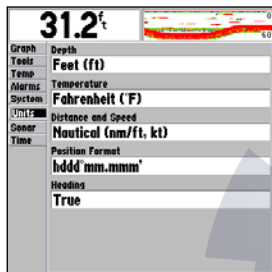

Main Menu—Units tab

The following settings are available:

- **Depth**—select units of measure for depth in **Feet (ft)**, **Fathoms (fa)**, or **Meters (m)**.
- **Temperature**—select units of measure for temperature in **Fahrenheit (°F)** or **Celsius (°C)**.
- **Distance and Speed**—select units of measure for distance and speed readouts in **Nautical (nm/ft, kt)**, **Nautical (nm/m, kt)**, **Statute (mi, mh)**, or **Metric (km, kh)** terms.
- **Position Format**—change the coordinate system in which a position reading is displayed. The default format is latitude and longitude in degrees, minutes, and thousandths of a

minute (**hddd°mm.mmm'**). The following additional formats are available: latitude/longitude in decimal degrees (**hddd.ddddd°**) and latitude/longitude in degrees, minutes, and seconds (**hddd°mm'ss.s''**).

- **Heading**—select the reference used in calculating heading information for the the following advanced data fields: **Bearing**, **Compass**, **Course**, and **Track** (pages 23-24). **True** will display data with reference to True North. **Magnetic** will display data with reference to Magnetic North using the magnetic variation value received in the RMC NMEA sentence (page 23).

Sonar Tab

The Sonar tab allows you to initialize settings and calibrations.

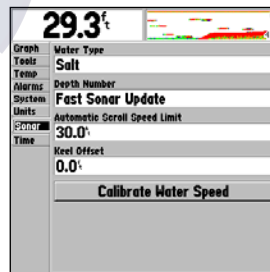

Main Menu—Sonar tab

The following settings are available:

- **Water Type**—allows you to select either **Fresh** or **Salt** to ensure accurate readings on the unit. Sound waves travel at different rates through each type.
- **Depth Number**—controls the efficiency of the digital depth update rate. **Fast Sonar Update** updates quicker and is recommended for low-noise, deeper water (>50 ft.). **Auto** is best for shallow water or high noise areas, has a slower screen update, and is best used if you travel a wide variety of depths. If the unit is unable to track the bottom for any reason, the digits in the depth window flash on and off to alert you.
- **Automatic Scroll Speed Limit**—matches the scroll rate (page 19) to the speed of your vessel (if equipped with a speed sensor or receiving GPS NMEA input). Entering your maximum cruising speed will produce a 100% scroll rate when you reach that speed. One half of that speed will produce a 50% scroll rate, etc.
- **Keel Offset**—allows you to offset the surface reading for the depth of a keel in order to measure depth from the bottom of your keel instead of from the transducer's location. Enter a positive number to offset for a keel. Enter a negative number to compensate for a large vessel that may draw several feet of water. The **Keel Offset** is reflected in the depth reading.
- **Transducer Type**—allows you to specify what type of transducer you are using, if you are not in Simulator mode. Do not use **User Defined** unless instructed to do so.
- **Calibrate Water Speed**—appears only if you are using a speed-capable transducer/sensor. Calibration is required to ensure that the **Water Speed** displayed on your unit is accurate. The unit automatically uses GPS ground speed (if available via NMEA input) for comparison on the calibration. If a GPS ground speed is not available, use either your boat's speedometer reading (not always accurate) or a stopwatch to determine your speed over a certain distance (distance / time = speed). It is recommended that the calibration take place in water having little or no current.

Transducer at surface

Enter a positive (+) Keel Offset number to show the depth from the bottom of the keel.



Transducer at bottom of keel

Enter a negative (-) Keel Offset number to show the depth from the surface.

To calibrate the water speed:

1. Use the **ARROW** keys to highlight **Calibrate Water Speed** and press **ENTER**.
2. Bring the boat to a cruising speed. Both the top GPS ground speed and uncalibrated water speed will be shown at the bottom of the calibration window. Note your top speed, then stop the boat and press **ENTER**.
3. By default, the top speed will automatically show in the **What was your top water speed?** field. If a ground speed is not available, the top uncalibrated water speed is used instead. If the new speed is correct, highlight **OK** and press **ENTER**. To manually enter a calibration, press **ENTER** on the speed field, enter a new speed and press **ENTER**.



***NOTE:** If the boat is not moving fast enough or the speed sensor is not registering a speed, a “Boat Is Not Moving Fast Enough To Calibrate” message is displayed at the bottom of the screen. Check that the speed sensor wheel is moving or safely increase boat speed. If there is a problem with the speed sensor/unit or if a speed sensor is not installed, a “Water Speed Sensor Is Not Working” message is displayed at the bottom of the screen. Check the connections of speed sensor cables.*

Time Tab

The Time tab displays the current time and date, allows you to adjust the 12- or 24-hour time format, select a time zone, and adjust for daylight saving to show correct local time. The time will only display if you are receiving valid NMEA input from a GPS unit (pages 8-9) or in Simulator mode. The following settings are available:

- **Time Format**—choose from 12- or 24-hour (military) format.
- **Time Zone**—choose the correct local time zone or enter your **UTC Offset**. The UTC (also called Greenwich mean time) offset is how many hours you are ahead or behind the time line.
- **Daylight Saving Time**—choose from **Auto**, **On**, or **Off** to adjust for daylight saving.
- **Current Time and Current Date**—display current time and date. Fields will be blank if not receiving a time from an attached GPS. It is not possible to edit these fields.

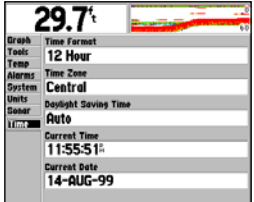

Main Menu—Time tab

Understanding Sonar

If you are unfamiliar with basic sonar or need help determining what appears on the graph, this section may benefit you. This section is intended to teach the novice user how the Fishfinder 250/250C operates and how it can help improve fishing productivity.

To understand what the unit is displaying, it is important to have a general knowledge of how the unit works and how it determines what to display. Basically, the unit operates by transmitting sound waves toward the bottom of a lake, stream, or seabed in a cone-shaped pattern. When a transmitted soundwave strikes an underwater object such as the bottom, a piece of structure, or a fish, sound is reflected back to the transducer. The transducer collects the reflected sound waves and sends the data to the unit to be processed and displayed on the graph. The underwater data is displayed on the graph in the order it is returned (first returned = first on the graph).

Generally speaking, if the only thing between the transducer and the bottom is water, the first strong return will come from the bottom directly below the transducer. The first strong return sets the bottom level. Weaker secondary returns provide the detailed data.

The Fishfinder 250 displays sonar returns as shades of gray; stronger returns are darker, and weaker returns are lighter. On the Fishfinder 250C, sonar returns appear as red (strongest), orange (strong), yellow (medium), green (weaker), and blue (weakest).

The diagram below shows an underwater scene as it would appear on the graph.

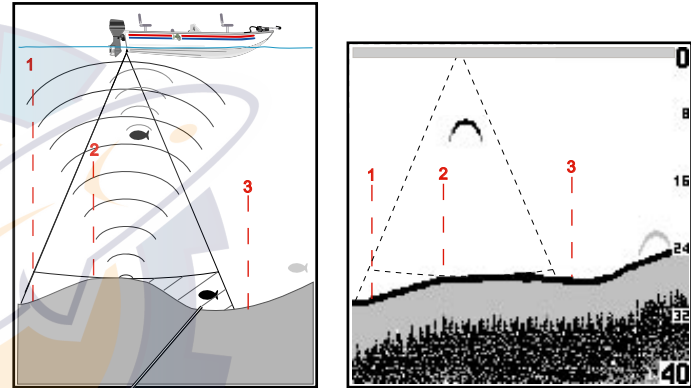

The fish in the diagram is currently in a dead zone and is not detected by the sonar. The fish is in the coverage area of the transducer, but the first strong return set the bottom level above the fish. The first strong return to reset the bottom level below the fish will enable the fish to be detected.

The following pages will show how this data can help you improve your fishing.

Transducer Coverage

The area covered by the transmitted sound waves is determined by the cone angle of the transducer and the water depth. Cone angles may vary among different types of transducers. For example, a 50kHz frequency may provide a wide 40° cone angle with a coverage width that is approximately 2/3 of the water depth. As shown in the diagram on the right, the 40° cone angle (50kHz frequency) approximately covers the area of a 20-foot diameter circle at a 30-foot depth. A 200kHz frequency may provide a narrow 10° cone angle with a coverage width that is approximately 2/10 of the water depth. As shown, the 10° cone angle (200kHz frequency) approximately covers the area of a 6-foot diameter circle at a 30-foot depth.

When using the Fishfinder 250/250C with **Frequency** set to **Dual**, the unit alternately transmits 50kHz and 200kHz signals and combines the information. This allows the unit to cover a large area and still retain good bottom resolution. The unit uses the narrow cone angle (200kHz) to display detailed bottom information (keeping dead zones to a minimum) and the wide cone angle (50kHz) for the large coverage area.

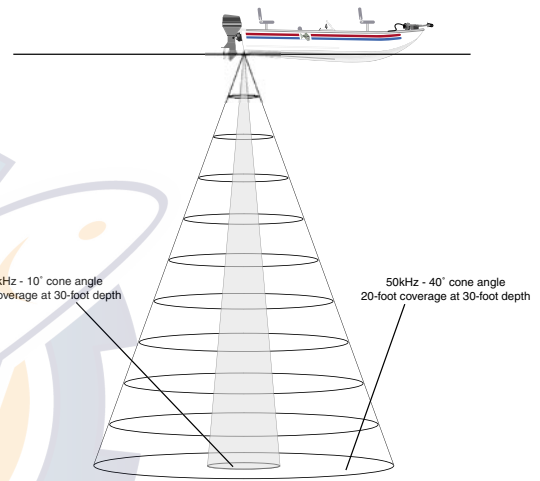

Transducer coverage

Fish returns from the wide and narrow beams appear differently on the display. The wide beam tends to show longer fish returns than the narrow beam, as shown below.



Wide cone angle



Narrow cone angle

Understanding the Graph

It is important to understand that the unit does not display a 3-D representation of the underwater environment. The unit can display multiple items at the same time and determine when they were received but not where they originated.

Examples 1 and 2 provide a look at the underwater world from a top view and illustrate how these views would be displayed on the graph. On both graphs it appears that the fish and tree are side-by-side, as shown in Example 1. However, when we look at Example 2, we see that the fish can be several feet from the tree. It is important to remember that the Fishfinder cannot determine where in the coverage area the tree or fish are, only that the returns were received at the indicated depths in the same time frame.



NOTE: Remember that the Fishfinder displays a 2-D picture of the underwater environment. The fish and tree could be located anywhere in the coverage area at that time.

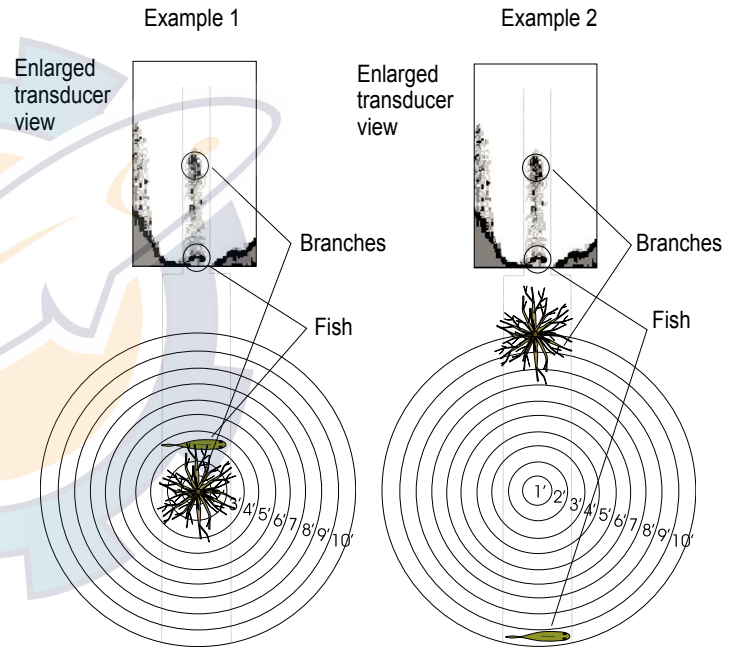

Whiteline

The Fishfinder 250/250C can help you to determine if the bottom is hard or soft. When the sonar soundwaves are reflected back by the bottom, a hard bottom returns a stronger signal than a soft bottom. A thin whiteline indicates a softer bottom while a thick whiteline indicates a harder bottom. Normally, the Fishfinder 250 uses a black line and the Fishfinder 250C uses a red line to show the point where water meets the bottom. This line follows the bottom contour, along with any significant objects lying on the bottom. The unit uses whiteline to make this bottom layer easier to distinguish.

With the Fishfinder 250/250C, whiteline helps accentuate where strong signals are located, which makes bottom type determination easier. The example to the right shows the bottom return with and without the whiteline activated. See page 18 for more information.

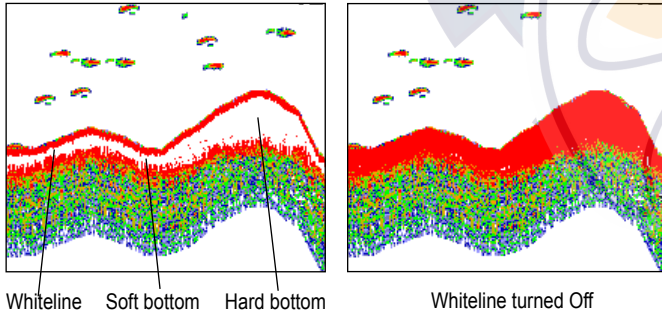

Whitelines can also help you to determine the type of bottom structure that is displayed on the graph. By determining the hardness of the structure, you can make a better informed decision on the type of structure.

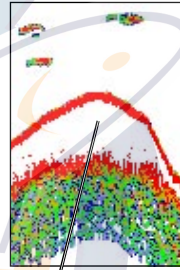

Structure is hard—
probably a rock or stump

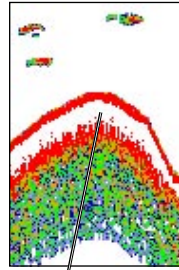

Structure is soft—
probably a mud pile

Thermoclines

One feature unique to Garmin is See-Thru® technology. See-Thru technology allows the Fishfinder 250/250C to “see” through thermoclines and locate fish where they live—and fish love thermoclines. A rough definition of a thermocline is a break in the water where the temperature changes faster than in the water above it. Thermoclines give weak returns and are shown as the weakest colors/shades (page 15).

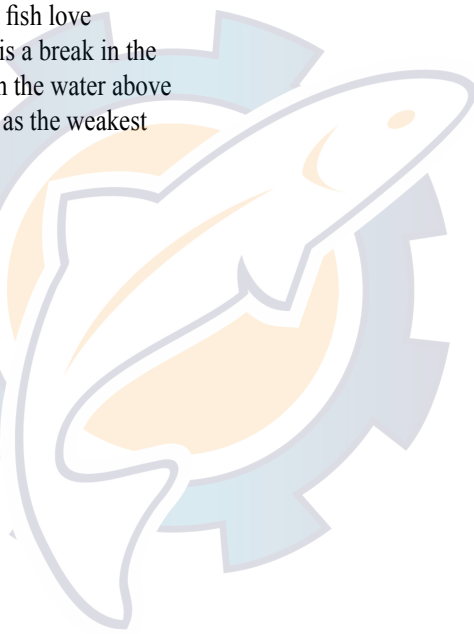
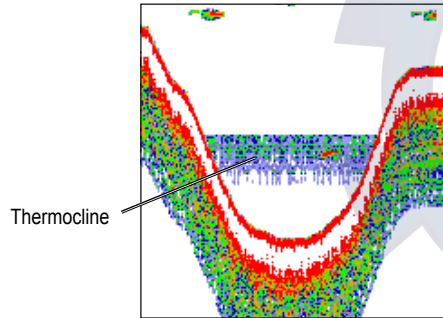

APPENDIX

Physical Specifications

Size:	6.1" W x 4.9" H x 2.9" D (15.5 cm x 12.5 cm x 7.4 cm)
Weight:	1.1 lbs. (0.5 kg)
Display:	(Fishfinder 250) 4.5" diagonal (11.4 cm), 3.2" W x 3.2" H (8.1 cm x 8.1 cm) high-contrast 10-level grayscale FSTN display with adjustable brightness (320 x 320 pixels) (Fishfinder 250C) 4.5" diagonal (11.4 cm), 3.2" W x 3.2" H (8.1 cm x 8.1 cm) high-contrast, 16-color CSTN display with adjustable brightness (320 x 320 pixels)
Case:	Fully gasketed, high-impact plastic alloy, waterproof to IEC 60529 IPX7 standards
Temp. Range:	5°F to 130°F (-15°C to 55°C)

Power

Source:	10-35 Volts DC
Usage:	17 watts max. at 10 volts DC; 15 watts at 13.8 volts DC nominal
Fuse:	2-Amp AGC/3AG

Sonar

Power:	Dual frequency: 500 watts (RMS); 4000 watts (peak to peak) Single frequency: 400 watts (RMS); 3200 watts (peak to peak)
Frequency:	50/200 kHz
Depth:	1500-foot max depth (Depth capacity is dependent on water salinity, bottom type and other water conditions.)

Cleaning and Storage

The Fishfinder 250/250C is constructed of high quality materials and does not require user maintenance other than cleaning. Clean the unit using a cloth dampened with a mild detergent solution and then wipe dry. Avoid chemical cleaners and solvents that may damage plastic components.

Do not store the Fishfinder 250/250C where prolonged exposure to temperature extremes may occur (such as in the trunk of a car) as permanent damage may result. Unit settings will be retained in the unit's memory without the need for external power.



WARNING: *The Fishfinder 250/250C lens is coated with a special anti-reflective coating that is very sensitive to skin oils, waxes, and abrasive cleaners. CLEANERS CONTAINING AMMONIA WILL HARM THE ANTI-REFLECTIVE COATING. It is very important to clean the lens using a lint-free, clean cloth and an eyeglass lens cleaner that is specified as safe for anti-reflective coatings.*

Messages and Alarms

The Fishfinder 250/250C uses an on-screen alert message system. Press the **ENTER** key to acknowledge a message.

Battery Alarm—The battery's voltage has fallen below the value entered in the Battery Alarm setup.

Battery Voltage High—The input voltage is too high; the unit will shut off. You must lower the input voltage.

Boat is not Moving Fast Enough to Calibrate—The boat is not moving fast enough for the speed wheel to provide a valid speed.

Can't Send Waypoint—The unit was unable to transmit the waypoint via the NMEA WPL sentence. Check the wiring.

Can't Read Voltages That High Limited To Top Of Range—The Voltage value in the Battery Alarm setup is higher than the unit can read.

Can't Read Voltages That Low Limited To Bottom Of Range—The Voltage value in the Battery Alarm setup is lower than the voltage where the unit automatically turns off.

Deep Water Alarm—The Deep Water Alarm depth has been reached.

Drift Alarm—The water depth has changed by the amount entered in the Drift Alarm setup.

Fish Alarm—A fish is detected. The unit displays an icon and beeps (if enabled). (This alarm does not display a message banner.)

Running Simulator—The unit is in Simulator mode. This message reappears after 2 minutes of inactivity. (If the unit does not detect a transducer attached, it automatically enters Simulator mode.)

Shallow Water Alarm—The Shallow Water Alarm depth has been reached.

Sonar Failed Unit Needs Repair—The unit has an internal problem. Contact your dealer or Garmin Product Support to have the unit serviced.

Timer Alarm—The Timer Alarm value has counted down to 00:00:00.

Transducer Disconnected Sonar Turned Off—The unit has no transducer attached, has a bad cable/transducer, or has a disconnected transducer cable. If the transducer cable is removed while the unit is on, reconnect and cycle power.

Water Speed Sensor is not Working—The speed sensor is not detected. Check the connections.

Water Temperature Alarm—The Water Temperature Alarm setting has reached a value above, below, inside, or outside of the specified value(s).

Software License Agreement

BY USING THE FISHFINDER 250/250C, YOU AGREE TO BE BOUND BY THE TERMS AND CONDITIONS OF THE FOLLOWING SOFTWARE LICENSE AGREEMENT. PLEASE READ THIS AGREEMENT CAREFULLY.

Garmin grants you a limited license to use the software embedded in this device (the “Software”) in binary executable form in the normal operation of the product. Title, ownership rights, and intellectual property rights in and to the Software remain in Garmin.

You acknowledge that the Software is the property of Garmin and is protected under the United States of America copyright laws and international copyright treaties. You further acknowledge that the structure, organization, and code of the Software are valuable trade secrets of Garmin and that the Software in source code form remains a valuable trade secret of Garmin. You agree not to decompile, disassemble, modify, reverse assemble, reverse engineer, or reduce to human readable form the Software or any part thereof or create any derivative works based on the Software. You agree not to export or re-export the Software to any country in violation of the export control laws of the United States of America.

WARNING: This product, its packaging, and its components contain chemicals known to the State of California to cause cancer, birth defects, or reproductive harm. This Notice is being provided in accordance with California’s Proposition 65. If you have any questions or would like additional information, please refer to our Web site at <http://www.garmin.com/prop65>.

Limited Warranty

This Garmin product is warranted to be free from defects in materials or workmanship for one year from the date of purchase. Within this period, Garmin will at its sole option repair or replace any components that fail in normal use. Such repairs or replacement will be made at no charge to the customer for parts or labor, provided that the customer shall be responsible for any transportation cost. This warranty does not cover failures due to abuse, misuse, accident or unauthorized alteration or repairs.

THE WARRANTIES AND REMEDIES CONTAINED HEREIN ARE EXCLUSIVE AND IN LIEU OF ALL OTHER WARRANTIES EXPRESS OR IMPLIED OR STATUTORY, INCLUDING ANY LIABILITY ARISING UNDER ANY WARRANTY OF MERCHANTABILITY OR FITNESS FOR A PARTICULAR PURPOSE, STATUTORY OR OTHERWISE. THIS WARRANTY GIVES YOU SPECIFIC LEGAL RIGHTS, WHICH MAY VARY FROM STATE TO STATE.

IN NO EVENT SHALL GARMIN BE LIABLE FOR ANY INCIDENTAL, SPECIAL, INDIRECT OR CONSEQUENTIAL DAMAGES, WHETHER RESULTING FROM THE USE, MISUSE, OR INABILITY TO USE THIS PRODUCT OR FROM DEFECTS IN THE PRODUCT. Some states do not allow the exclusion of incidental or consequential damages, so the above limitations may not apply to you.

Garmin retains the exclusive right to repair or replace the unit or software or offer a full refund of the purchase price at its sole discretion. SUCH REMEDY SHALL BE YOUR SOLE AND EXCLUSIVE REMEDY FOR ANY BREACH OF WARRANTY.

To obtain warranty service, contact your local Garmin authorized dealer or call Garmin Product Support for shipping instructions and an RMA tracking

number. The unit should be securely packed with the tracking number clearly written on the outside of the package. The unit should then be sent, freight charges prepaid, to any Garmin warranty service station. A copy of the original sales receipt is required as the proof of purchase for warranty repairs.

Garmin International, Inc.
1200 E 151st Street
Olathe, Kansas 66062 U.S.A.
Tel. 913/397.8200
Fax. 913/397.8282

Garmin (Europe) Ltd.
Unit 5, The Quadrangle
Abbey Park Industrial Estate
Romsey, SO51 9DL U.K.
Tel. 44/0870.8501241
Fax 44/0870.8501251

Online Auction Purchases: Products sold through online auctions are not eligible for rebates or other special offers from Garmin. Online auction confirmations are not accepted for warranty verification. To obtain warranty service, an original or copy of the sales receipt from the original retailer is required. Garmin will not replace missing components from any package purchased through an online auction.

International Purchases: A separate warranty is provided by international distributors for units purchased outside the United States. This warranty is provided by the local in-country distributor and this distributor provides local service for your unit. Distributor warranties are only valid in the area of intended distribution. Units purchased in the United States or Canada must be returned to the Garmin service center in the United Kingdom, the United

States, Canada, or Taiwan for service.

The Garmin Fishfinder 250/250C has no user-serviceable parts. Should you ever encounter a problem with your unit, please take it to an authorized Garmin dealer for repairs.

The Fishfinder 250/250C is fastened shut with screws. Any attempt to open the case to change or modify the unit in any way will void your warranty and may result in permanent damage to the equipment.

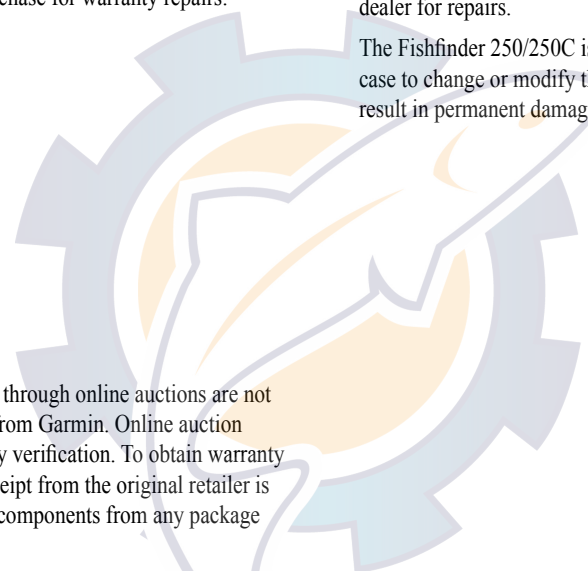

INDEX

A

Accessories 2
Adjustment Menu 16
Advanced Data Fields 23
Alarms 25
Alarms Tab 25
ARROW Keys 13
Automatic Scroll Speed 29

B

Background Color 22
Backlight 13
Basic display 23
Battery Alarm 26
Beeper 27
Bottom Lock 18
Bottom Split 18

C

Calibrate Water Speed 29, 30
Cleaning 36
Color, Background 22
Color Bar 23
Contrast 13
Custom Range 22

D

Data Fields 14, 23

40

Date 30
Daylight Saving Time 30
Deep Water Alarm 26
Defaults 19, 27
Depth 14, 17, 20, 22, 28
Depth Line 19
Depth Number 22, 29
Depth Units 28
Display Mode 27
Distance Units 28
Drift Alarm 26

E

ENTER Key 13

F

Factory Settings 27
Fish Alarm 26
Fish Symbols 15, 22
Flasher 23
Fuse 7

G

Gain 18
Graph 33
Graph Tab 21

H

Heading 28

I

Installation 3, 12

K

Keel Offset 29

L

Language Selection 27
Log and Graph Scale 25
Log Duration 25

M

Main Menu 22
MENU Key 13

N

NMEA 8, 20, 27, 29, 30
NMEA Setup 27
Noise Reject 19
Number Size 22

P

Packing List 1
Pointer 8, 13, 16, 20, 24
Position Format 28
POWER/BACKLIGHT key 12, 13
Power Up 12
Preface iii

R

Range 17
Registration iii

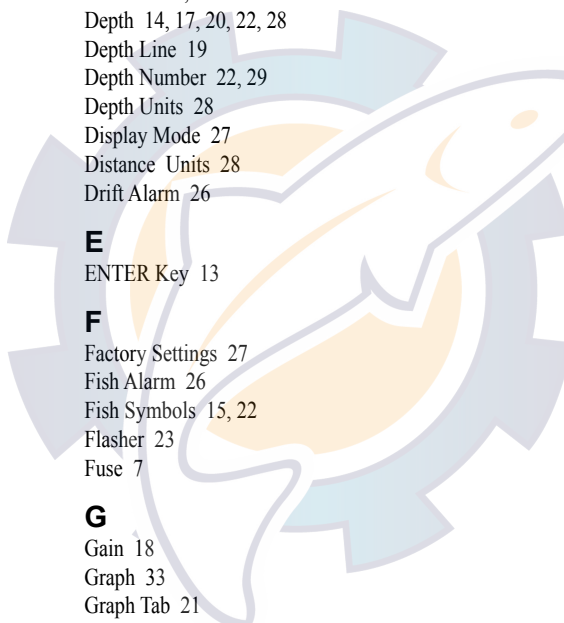

Reset Odometer 27

Reset Scale 25

S

Scale 22

Scroll 19, 20

Scroll Speed 29

Setting an Alarm 26

Set Up Tab 33

Shallow Water Alarm 26

Simulator 27

Size Split 19

Software Version 27

Sonar, Understanding 31, 32, 34

Sonar Page 14

Span 18

Specifications 36

Speed Units 28

Split Screen 17, 19

Storage 36

System Tab 27

T

Target Level 18

Temperature 22

Temperature Graph 23

Temperature Tab 25

Temperature Units 28

Testing the Installation 12

Time 30

Timer 26

Time Duration 25

Time Format 30

Time Tab 33

Time Zone 30

Tools Tab 23

Transducer 2, 11, 12, 19, 31, 32

Transducer Type 29

U

Understanding Sonar 33, 34

Understanding the Graph 33

Units Tab 28

V

View 18

W

Water Speed 22, 23, 29

Water Temperature 23

Water Temperature Alarm 26

Water Type 29

Whiteline 18, 34

Z

Zoom 15, 17

ZOOM Key 13

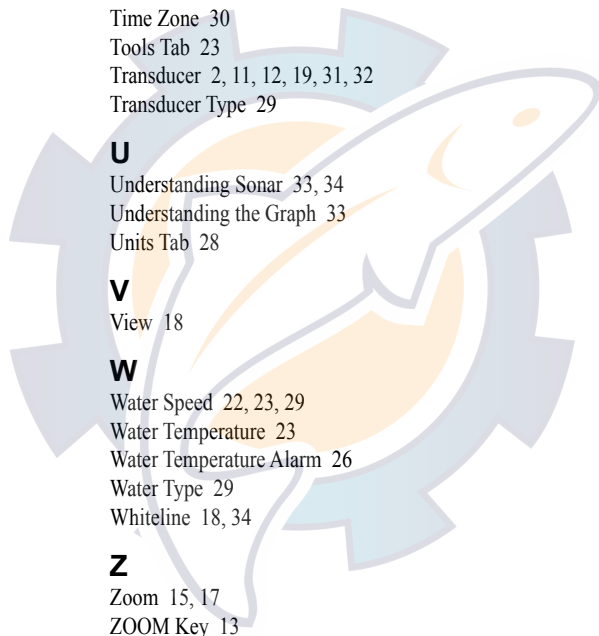

For the latest free software updates (excluding map data) throughout the life of your Garmin products, visit the Garmin Web site at www.garmin.com.



© Copyright 2005 Garmin Ltd. or its subsidiaries

Garmin International, Inc.
1200 East 151st Street, Olathe, Kansas 66062, U.S.A.

Garmin (Europe) Ltd.
Unit 5, The Quadrangle, Abbey Park Industrial Estate, Romsey, SO51 9DL, U.K.

Garmin Corporation
No. 68, Jangshu 2nd Road, Shijr, Taipei County, Taiwan

www.garmin.com

Part Number 190-00328-00 Rev. B